

# FORMES ET COULEURS

## Collection PEDRERA



epoxia  
mobilier et aménagement de bureau

### Chaise

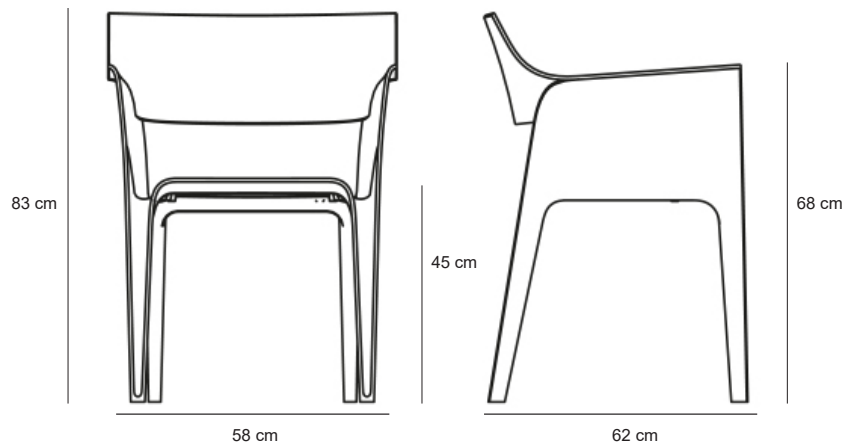

Fauteuil L.58 x P.62 x H.83 cm. Hauteur d'assise 45 cm

### Polypropylène basic



### Révolution - *fabriquée à partir de plastique recyclé de la Méditerranée*

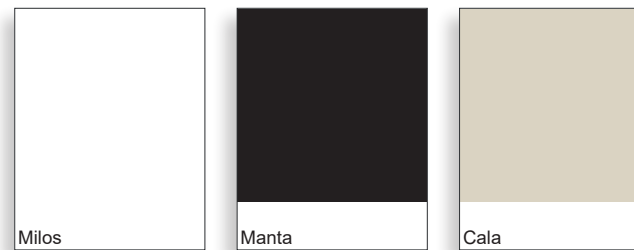

### Laqué

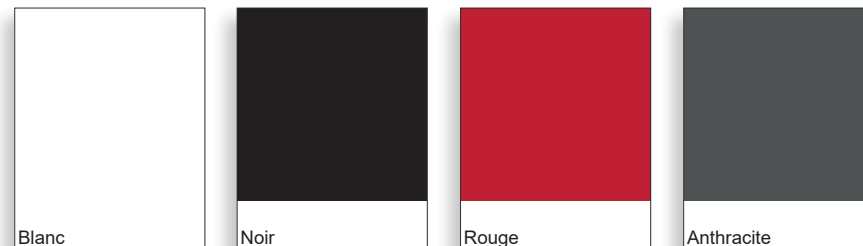

# FORMES ET COULEURS

## Collection PEDRERA



epoxia  
mobilier et aménagement de bureau

Tissu Nautical pour coussin - 100% polyester enduit pvc - martindale 120 000 tours.



3102  
Blanc

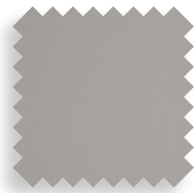

3111  
Ecrû



3105  
Beige

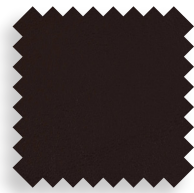

3120  
Bronze

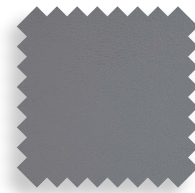

3112  
Steel

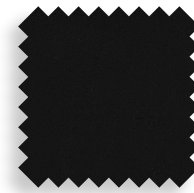

3126  
Noir

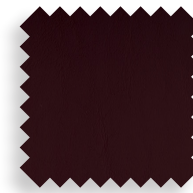

3119  
Prune



3124  
Navy

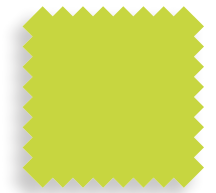

0041  
Pistache



3117  
Rouge

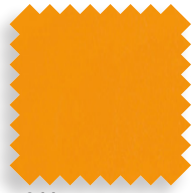

3115  
Orange

Tissu Silvertex® pour coussin - 100% polyester enduit pvc - martindale 300 000 tours.

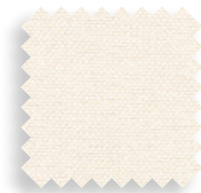

4004  
Blanc



5008  
Pistache

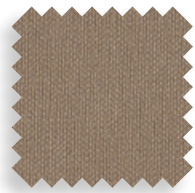

0009  
Ecrû