



Conseil, devis, aménagement 01 39 66 00 77 du lundi au vendredi de 9h à 18h

GARANTIE
2
ANS

LIVRAISON
MONTAGE

MADE IN
EU
EUROPE

Viga



EPOXIA

Epoxia - 6 avenue Charles de Gaulle - 78150 Le Chesnay - +33 1 39 66 00 77 - contact@epoxia.com - www.epoxia.com



V03P desk
1800/1800/740

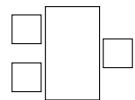

BL5P13 x6 chair
533/535/754

SAVA chair
640/610/1145-1335



M06 Mediabox



M10 Top access

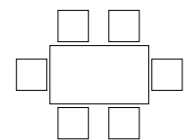

V220S conference table
2200/1100/740

BL4P14 x6 chair
533/535/754



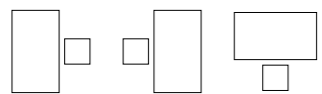

V16 desk
1600/800/740

BL1P14 chair
533/535/754

V1619 high table
1600/1000/900

TE11H high stool
500/430/773

V16111 high table
1600/1000/1100

AF02 high stool
567/530/1098



Viga

by Yonoh Studio

Bureaux - plateau

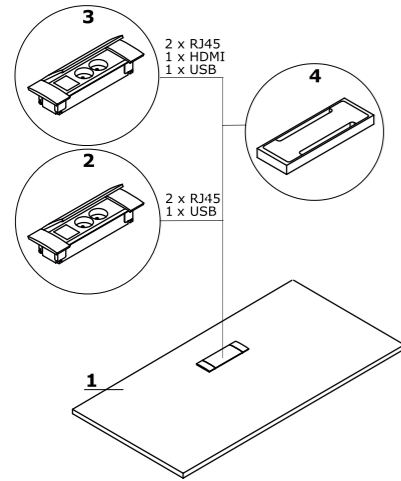

1. Plan de travail - épaisseur de 30 mm, placage/stratifié HPL

OPTION PAYANTE :

2. Mediabox M06 - 2x230V+USB charger, couleur: noir
3. Mediabox M06H - 2x230V+HDMI+USB, couleur: noir
4. Top access M10 - couleur: FENIX - noir mat, MDF
5. Passage de câbles - la largeur de l'ouverture est proportionnelle à la largeur du plan de travail

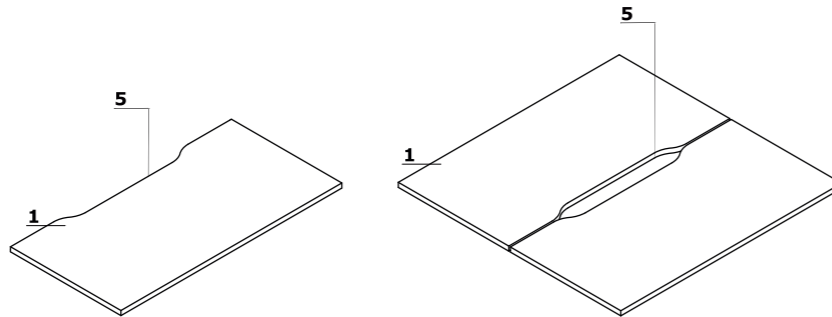

Bureau avec meuble retour

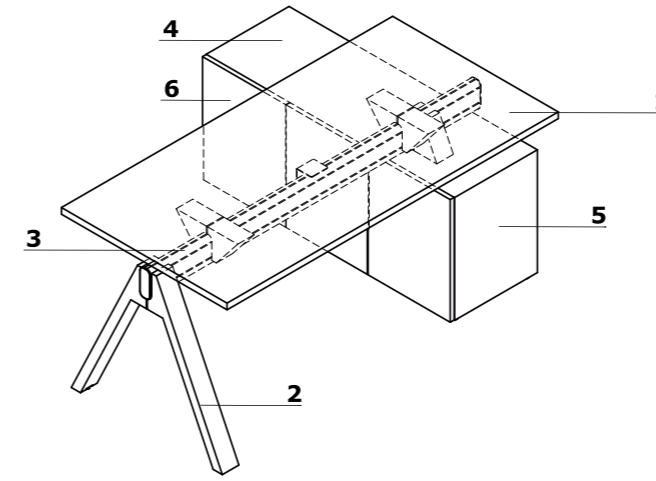

1. Plan de travail - épaisseur de 30 mm, placage/stratifié HPL
2. Pied - pied en bois - chêne, profil 80x40mm
3. Structure - aluminium anodisé, couleur : noir; distance entre le dessus et le cadre de 30 mm
4. Top - épaisseur de 19 mm, placage
5. Corps - épaisseur de 19 mm, placage
6. Façade - Systeme "Push-to-Open", épaisseur de 19 mm, placage

Piètement

1. Pied - pied en bois - chêne, profil 80x40mm
2. Structure - aluminium anodisé, couleur : noir; distance entre le dessus et le cadre de 30 mm

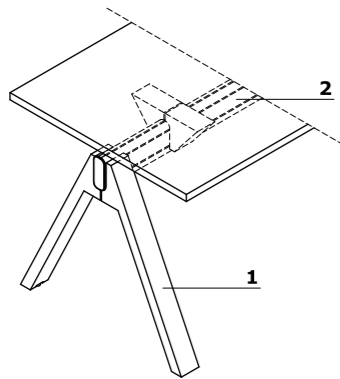

Extensions - pour bureaux bench

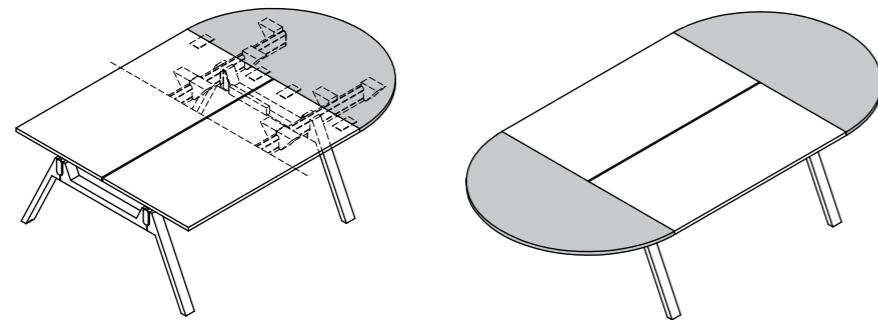

Bureaux de direction - plateau

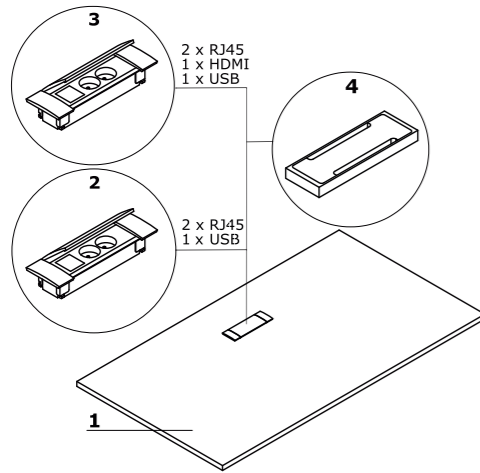

1. Plan de travail - épaisseur de 30 mm, placage/stratifié HPL

OPTION PAYANTE :

- 2. Mediabox M06 - 2x230V+USB charger, couleur: noir
- 3. Mediabox M06H - 2x230V+HDMI+USB, couleur: noir
- 4. Top access M10 - couleur: FENIX - noir mat, MDF

Bureau avec meuble retour

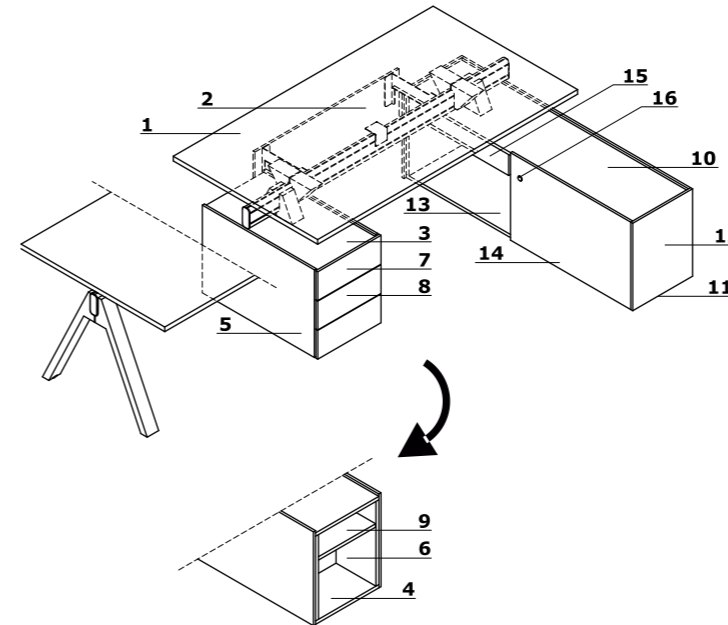

- 1. Plan de travail - épaisseur de 30 mm, placage/stratifié HPL
- 2. Voile de fond - épaisseur de 13 mm, placage; poignée - finition peinture poudre époxy, couleur : noir

CAISSON :

- 3. Top - épaisseur de 19 + 14 mm, placage/stratifié HPL
- 4. Base - épaisseur de 19 mm, placage
- 5. Corps extérieur - épaisseur de 14 mm, HPL - Fenix
- 6. Corps intérieur - épaisseur de 19 mm, placage
- 7. Façade - épaisseur de 13 mm, placage
- 8. Tiroirs mélaminé - glissières à billes, charge max 25 kg, extraction 100% serrure centralisée assure la fermeture de l'ensemble des tiroirs, amortisseur de fermeture
- 9. Tablette - épaisseur de 19 mm, protection contre les chutes accidentelles, placage

CRÉDENCE DE DIRECTION :

- 10. Top - épaisseur de 19 + 14 mm, placage/stratifié HPL
- 11. Base - épaisseur de 19 mm, placage
- 12. Corps extérieur - épaisseur de 14 mm, HPL - Fenix
- 13. Corps intérieur - épaisseur de 19 mm, placage
- 14. Portes coulissantes - épaisseur de 18 +13 mm, fermeture silencieuse, placage
- 15. Tiroirs mélaminé - glissières à billes, extraction 100% serrure centralisée assure la fermeture de l'ensemble des tiroirs, amortisseur de fermeture
- 16. Serrure

BUREAU AVEC MEUBLE RETOUR (MEUBLE AVEC RANGEMENTS DES DEUX CÔTÉS) :

- 17. Top - épaisseur de 19 + 14 mm, placage/stratifié HPL
- 18. Base - épaisseur de 19 mm, placage
- 19. Corps extérieur - épaisseur de 14 mm, HPL - Fenix
- 20. Corps intérieur - épaisseur de 19 mm, placage
- 21. Portes coulissantes - épaisseur de 18 +13 mm, fermeture silencieuse, placage
- 22. Tiroirs mélaminé - glissières à billes, extraction 100% serrure centralisée assure la fermeture de l'ensemble des tiroirs, amortisseur de fermeture
- 23. Serrure

Piètement

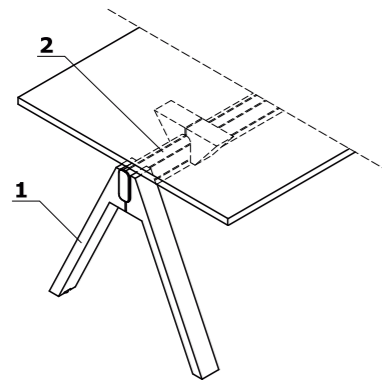

- 1. Pied - pied en bois - chêne, profil 80x40mm
- 2. Structure - aluminium anodisé, couleur : noir; distance entre le dessus et le cadre de 30 mm

Armoires et rangements

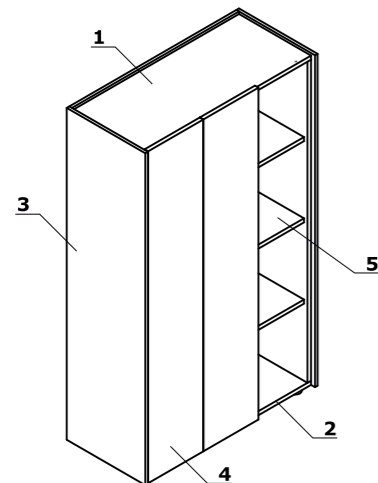

- 1. Top - épaisseur de 20 mm, HPL - Fenix
- 2. Base - épaisseur de 19 mm, placage
- 3. Corps extérieur - épaisseur de 14 mm, HPL - Fenix
- 4. Façade - Systeme "Push-to-Open", épaisseur de 19 mm, placage
- 5. Tablette - épaisseur de 19 mm, protection contre les chutes accidentelles, placage

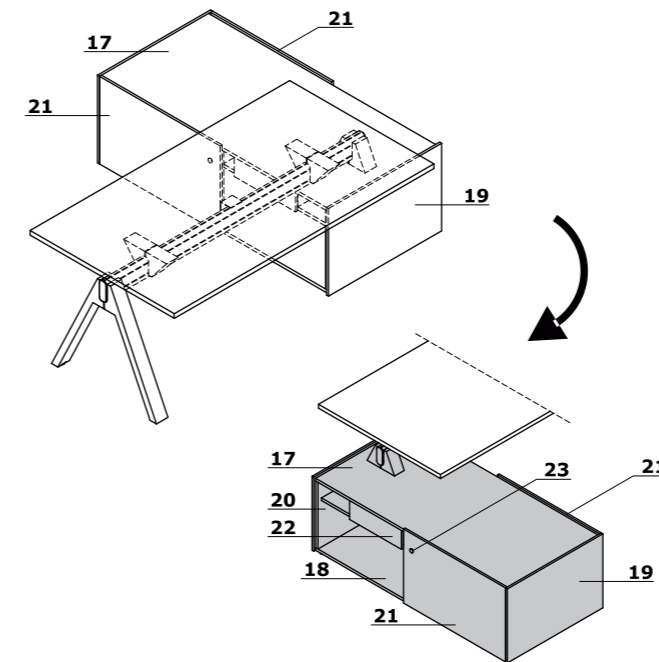

Bureaux avec réglage en hauteur électrique

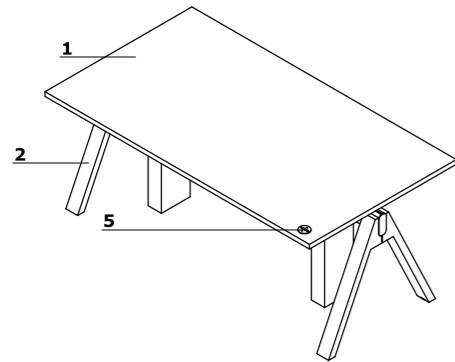

1. **Plan de travail** - épaisseur de 30 mm, placage/stratifié HPL
2. **Pied** - pied en bois - chêne, profil 80x40mm
3. **Structure avec réglage électrique de la hauteur** - métal, couleur : noir ; charge max. 100 kg - avec répartition uniforme de la pression sur le plan de travail, réglage 758 - 1272 mm
4. **Boîtier du mécanisme** - MDF, couleur : noir
5. **Panneau de contrôle** - avec mémorisation de hauteur; possibilité de régler la sensibilité du système anti-collision sur 3 niveaux : faible, moyen, élevé
6. **Chemin de câbles** - métal finition peinture poudre époxy
7. **Chemin de câble vertical** - plastique, couleur : noir ; fixé au plan de travail et au chemin de câbles

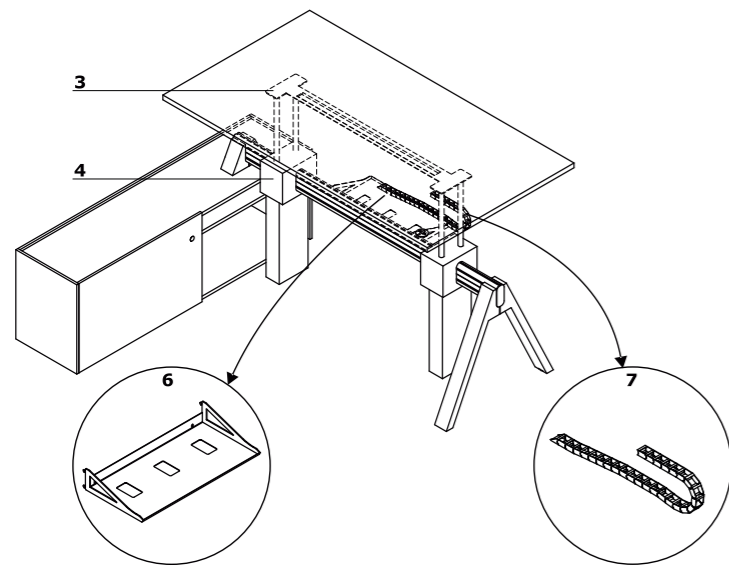

Dimensions

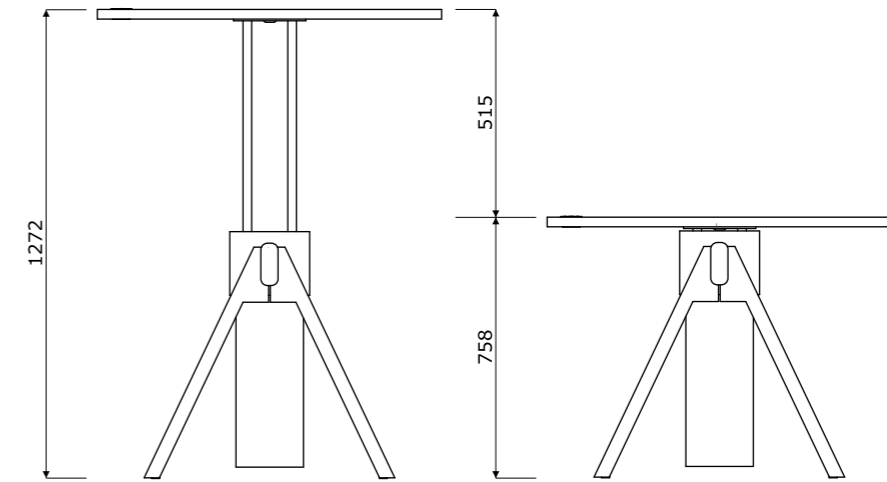

Spécificités techniques du piétement

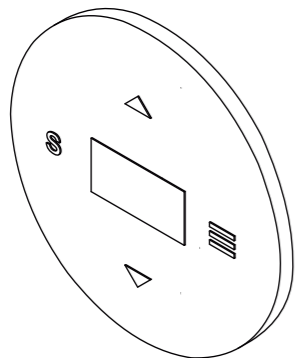

- **Élévation** - 40 mm/s Super Soft - Start
- **Propulsion** - 2 moteurs synchrones contrôlés par un microprocesseur avec sécurité de surcharge
- **Système de sécurité** - ISP - Intelligent System Protection
- **Normes** - EN 527-2
- **Directives** - 206/95EC, UI508 1999, UL1004 R7 06, WE DC 2004/108WE
- **Alimentation** - 230V, puissance 300W, consommation en veille - 0.3W

Caissons

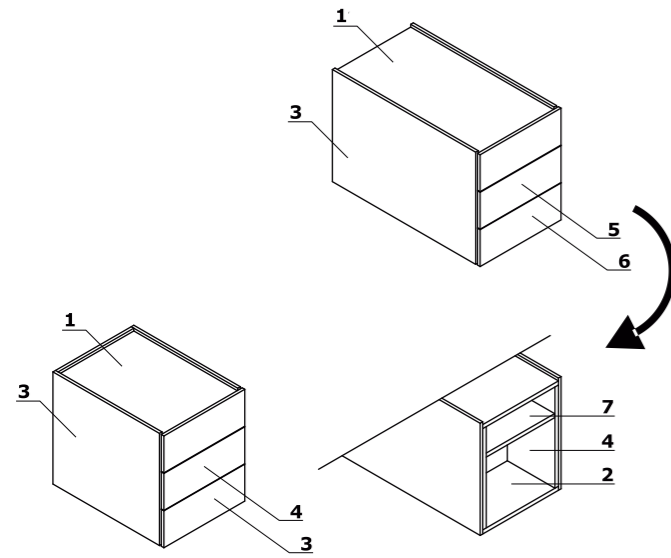

1. Top - épaisseur de 19 + 14 mm, placage/stratifié HPL
2. Base - épaisseur de 19 mm, placage
3. Corps extérieur - épaisseur de 14 mm, HPL - Fenix
4. Corps intérieur - épaisseur de 19 mm, placage
5. Façade - épaisseur de 13 mm, placage
6. Tiroirs mélaminé - glissières à billes, extraction 100% serrure centralisée assure la fermeture de l'ensemble des tiroirs, amortisseur de fermeture
7. Tablette - épaisseur de 19 mm, protection contre les chutes accidentelles, placage

Tables hautes

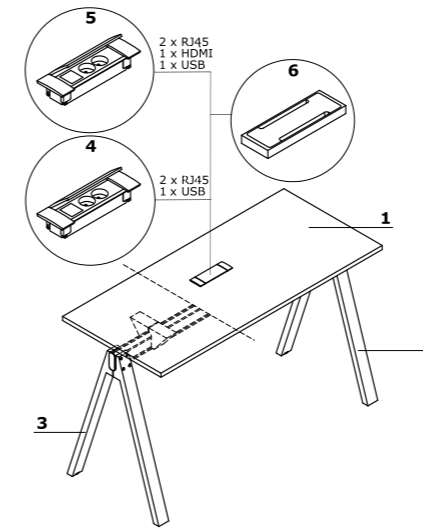

1. Plan de travail - épaisseur de 30 mm, placage/stratifié HPL
2. Pied - pied en bois - chêne, profil 80x40mm
3. Vérins de réglage - course de 5 mm

OPTION PAYANTE :

4. Mediabox M06 - 2x230V+USB charger, couleur : noir
5. Mediabox M06H - 2x230V+HDMI+USB, couleur : noir
6. Top access M10 - couleur : FENIX - noir mat, MDF

Tables et tables de réunion

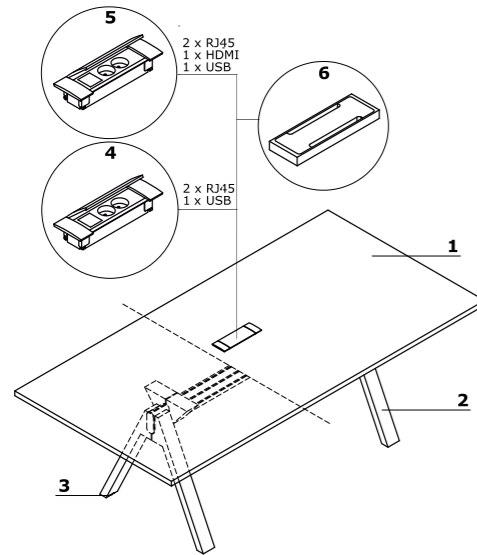

1. Plan de travail - épaisseur de 30 mm, placage/stratifié HPL
2. Pied - pied en bois - chêne, profil 80x40mm
3. Vérins de réglage - course de 5 mm

OPTION PAYANTE :

4. Mediabox M06 - 2x230V+USB charger, couleur : noir
5. Mediabox M06H - 2x230V+HDMI+USB, couleur : noir
6. Top access M10 - couleur : FENIX -noir mat, MDF

Emplacement mediabox

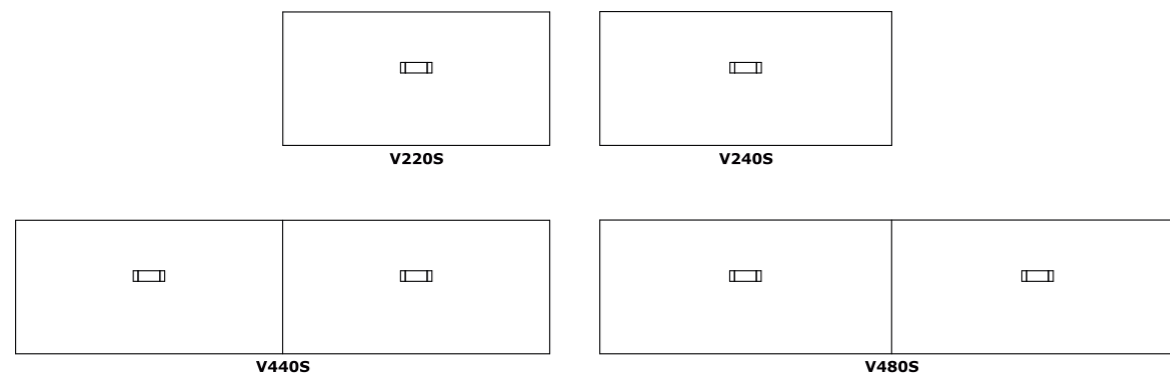

Bureaux droits *

V16
1600 / 800 / 740
72 kg

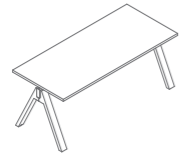

V18
1800 / 800 / 740
139.31 kg

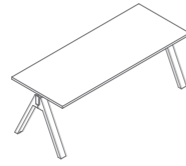

V20
2000 / 800 / 740
86.1 kg

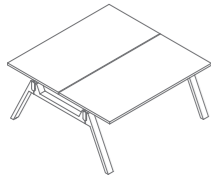
Benches *

V216
1600 / 1610 / 740
148 kg

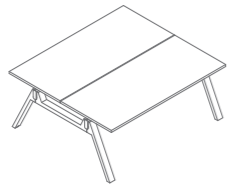

V218
1800 / 1610 / 740
162.1 kg

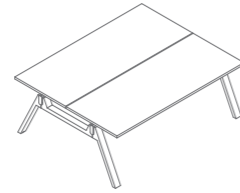

V220
2000 / 1610 / 740
176.2 kg

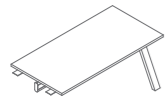
Élément suivant - pour bureau droit *

V16L
1600 / 800 / 740
68.3 kg

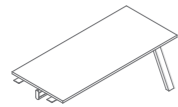

V18L
1800 / 800 / 740
135.61 kg

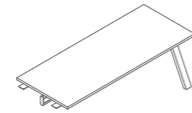

V20L
2000 / 800 / 740
82.4 kg

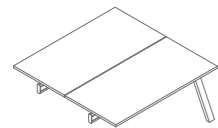
Élément suivant - pour bench *

V216L
1600 / 1610 / 740
142 kg

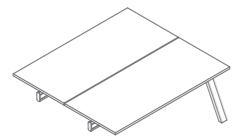

V218L
1800 / 1610 / 740
156.1 kg

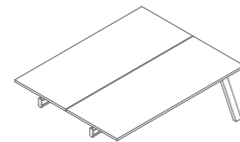

V220L
2000 / 1610 / 740
170.2 kg

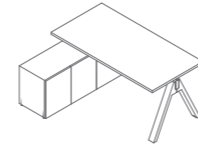
Bureau avec meuble retour *

V163L
1600 / 1300 / 740
112.5 kg

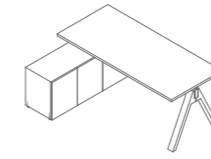

V183L
1800 / 1300 / 740
119.55 kg

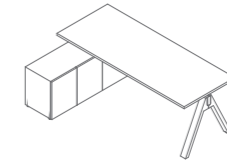

V203L
2000 / 1300 / 740
126.6 kg

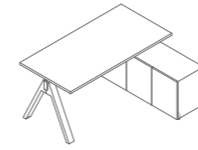

V163P
1600 / 1300 / 740
112.5 kg

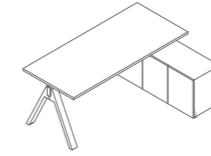

V183P
1800 / 1300 / 740
119.55 kg

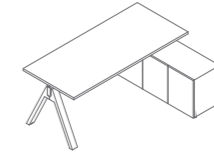

V203P
2000 / 1300 / 740
126.6 kg

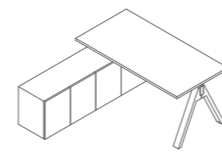

V164L
1600 / 1700 / 740
123.5 kg

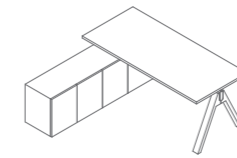

V184L
1800 / 1700 / 740
130.55 kg

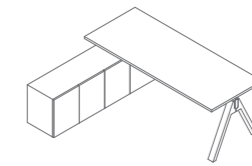

V204L
2000 / 1700 / 740
137.6 kg

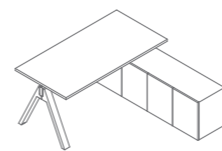

V164P
1600 / 1700 / 740
123.5 kg

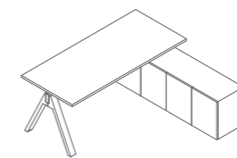

V184P
1800 / 1700 / 740
130.55 kg

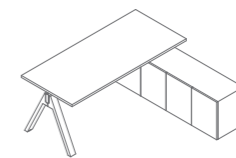

V204P
2000 / 1700 / 740
137.6 kg

Bureau avec meuble retour *

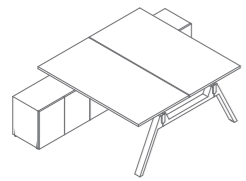

V1623
1600 / 2400 / 740
237 kg

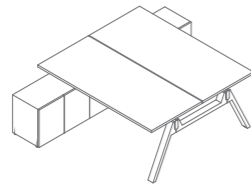

V1823
1800 / 2400 / 740
251.1 kg

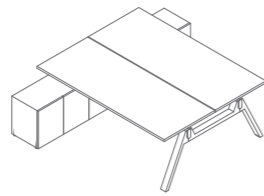

V2023
2000 / 2400 / 740
265.2 kg

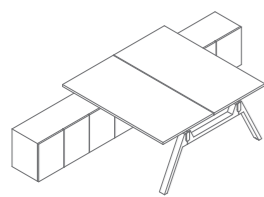

V1624
1600 / 3200 / 740
259 kg

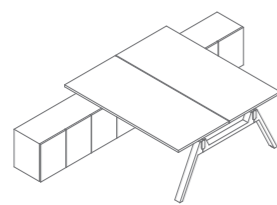

V1824
1800 / 3200 / 740
273.1 kg

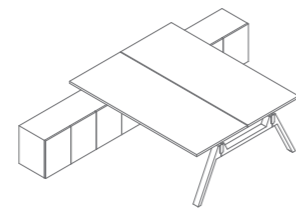

V2024
2000 / 3200 / 740
287.2 kg

Accessoires *

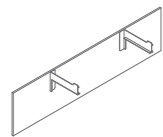

V16B
1600 / 340 / 400
11.13 kg

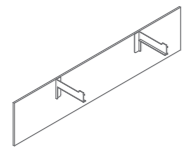

V18B
1800 / 340 / 400
11.81 kg

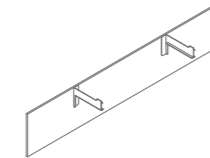

V20B
2000 / 340 / 400
12.5 kg

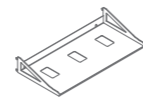

V34
550 / 280 / 85
3 kg

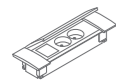

M06
245 / 80 / 50
1 kg

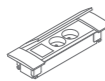

M06H
245 / 80 / 50
1 kg

Bureaux de direction *

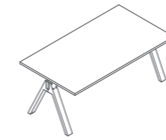

V01
1800 / 1000 / 740
92.45 kg



V02
2000 / 1000 / 740
100.94 kg

Bureau avec meuble retour *

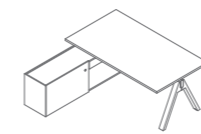

V03L
1800 / 1800 / 740
152.45 kg

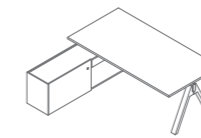

V04L
2000 / 1800 / 740
160.94 kg



V03P
1800 / 1800 / 740
152.45 kg

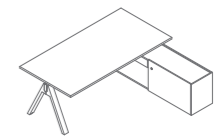

V04P
2000 / 1800 / 740
160.94 kg

Bureau avec meuble retour – meuble avec rangements des deux côtés *

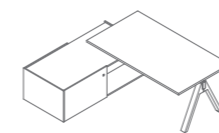

V05L
1800 / 1000 / 740
186.45 kg

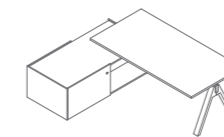

V06L
2000 / 1000 / 740
194.94 kg

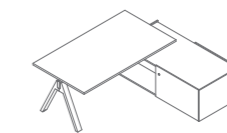

V05P
1800 / 1000 / 740
186.45 kg

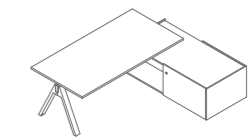

V06P
2000 / 1000 / 740
194.94 kg

Bureaux avec caisson porteur *

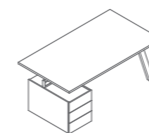

V07L
1800 / 1000 / 740
134.95 kg

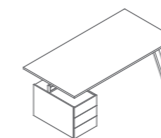

V08L
2000 / 1000 / 740
143.44 kg

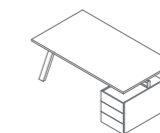

V07P
1800 / 1000 / 740
134.95 kg

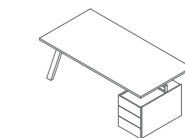

V08P
2000 / 1000 / 740
143.44 kg

Bureaux avec meuble retour et caisson porteur *

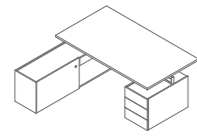

V09L
1800 / 1800 / 740
194.95 kg

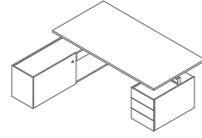

V10L
2000 / 1800 / 740
203.44 kg

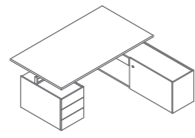

V09P
1800 / 1800 / 740
194.95 kg

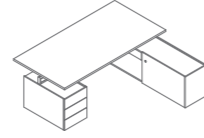

V10P
2000 / 1800 / 740
203.44 kg

Bureaux avec réglage en hauteur électrique sur meuble retour porteur *

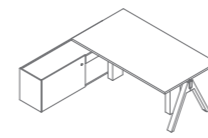

V03LR
1800 / 1800 / 740
159.66 kg

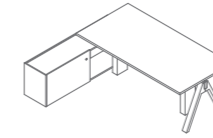

V04LR
2000 / 1800 / 740
167.72 kg

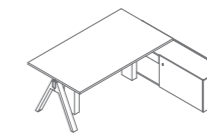

V03PR
1800 / 1800 / 740
159.66 kg

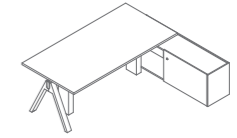

V04PR
2000 / 1800 / 740
167.72 kg

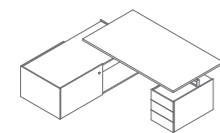

V37L
2144 / 1800 / 740
228.95 kg

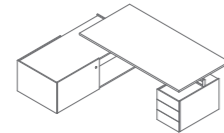

V38L
2344 / 1800 / 740
237.44 kg

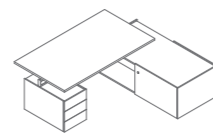

V37P
2144 / 1800 / 740
228.95 kg

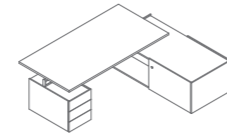

V138P
2344 / 1800 / 740
237.44 kg

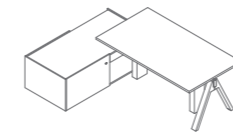

V05LR
2144 / 1800 / 740
193.66 kg

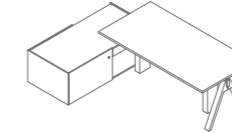

V06LR
2344 / 1800 / 740
201.72 kg

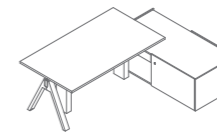

V05PR
2144 / 1800 / 740
193.66 kg

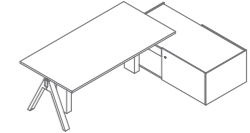

V06PR
2344 / 1800 / 740
201.72 kg

Crédence de direction *

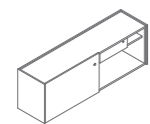

V35
1602 / 416 / 545
62.5 kg

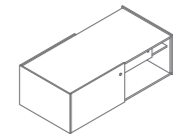

V36
1602 / 784 / 545
96.5 kg

Bureaux avec réglage en hauteur électrique et caisson *

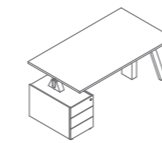

V07LR
1800 / 1000 / 740
142.16 kg

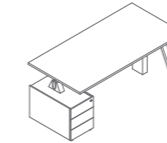

V08LR
2000 / 1000 / 740
150.22 kg

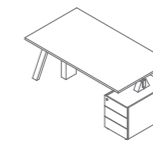

V07PR
1800 / 1000 / 740
142.16 kg

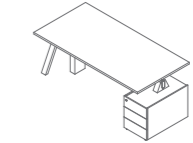

V08PR
2000 / 1000 / 740
150.22 kg

Bureaux de direction avec réglage en hauteur électrique *

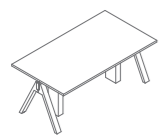

V01R
1800 / 1000 / 740
99.66 kg

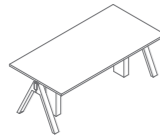

V02R
2000 / 1000 / 740
107.72 kg

Bureaux avec réglage en hauteur électrique, crédence de direction et caisson *

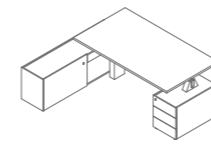

V09LR
1800 / 1000 / 740
202.16 kg

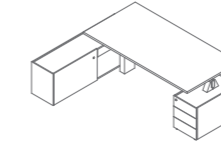

V10LR
2000 / 1000 / 740
210.22 kg

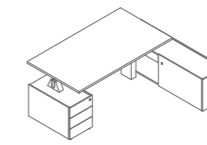

V09PR
1800 / 1000 / 740
202.16 kg

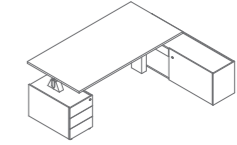

V10PR
2000 / 1000 / 740
210.22 kg

Bureaux avec réglage en hauteur électrique, crédence de direction et caisson *

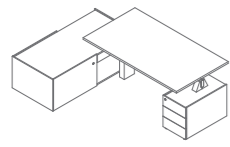

V37LR
2540 / 1000 / 740
236.16 kg

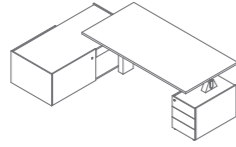

V38LR
2740 / 1000 / 740
244.22 kg

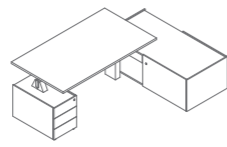

V37PR
2540 / 1000 / 740
236.16 kg

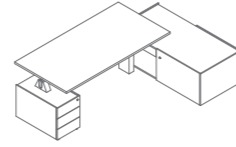

V38PR
2740 / 1000 / 740
244.22 kg

Armoires et rangements *

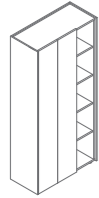

V22
928 / 424 / 1944
132 kg

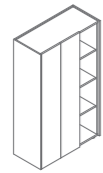

V23
928 / 424 / 1565
104.5 kg



V24
828 / 424 / 807
56 kg

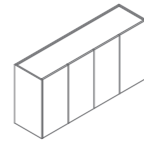

V25
1628 / 424 / 807
104 kg



V26
828 / 424 / 807
44 kg

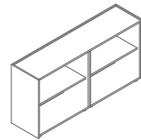

V27
1628 / 424 / 807
79 kg



V28
828 / 424 / 807
53.95 kg

Caissons *

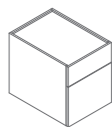

V12K
438 / 600 / 545
35 kg

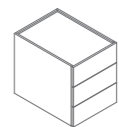

V13K
438 / 600 / 545
35 kg



V14K
438 / 800 / 545
45 kg

Éléments supplémentaires *

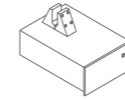

V11
436 / 600 / 216
16.5 kg

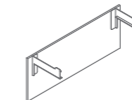

V10B
1000 / 340 / 400
7.9 kg

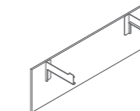

V12B
1200 / 340 / 400
8.5 kg

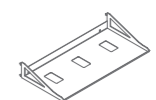

V34
550 / 280 / 85
3 kg

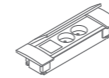

M06
245 / 80 / 50
1 kg

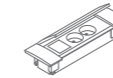

M06H
245 / 80 / 50
1 kg

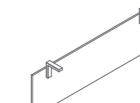

V18BE
1370 / 400 / 13
5 kg

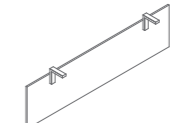

V20BE
1570 / 400 / 13
6 kg



V34S
220 / 160 / 50
0.5 kg

Tables et tables de réunion *



V220S
2200 / 1100 / 740
113.9 kg



V240S
2400 / 1100 / 740
123.12 kg

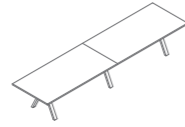

V440S
4400 / 1100 / 740
227.8 kg

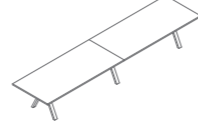

V480S
4800 / 1100 / 740
246.26 kg

Tables hautes *



V169
1600 / 800 / 900
73.5 kg



V189
1800 / 800 / 900
80.55 kg



V209
2000 / 800 / 900
87.6 kg



V1611
1600 / 800 / 1100
74.5 kg



V1811
1800 / 800 / 1100
81.55 kg



V2011
2000 / 800 / 1100
88.6 kg



V1619
1600 / 1000 / 900
81.36 kg



V1819
1800 / 1000 / 900
90.29 kg



V2019
2000 / 1000 / 900
105.22 kg

* Dimensions exprimées en millimètre : Largeur x Profondeur x Hauteur

Tables hautes *



V16111
1600 / 1000 / 1100
182.36 kg



V18111
1800 / 1000 / 1100
91.29 kg



V20111
2000 / 1000 / 1100
106.22 kg

Éléments a multiplier les postes *



V169L
1600 / 800 / 900
69.1 kg



V189L
1800 / 800 / 900
76.15 kg



V209L
2000 / 800 / 900
83.2 kg



V1611L
1600 / 800 / 1100
769.8 kg



V1811L
1800 / 800 / 1100
76.85 kg



V2011L
2000 / 800 / 1100
83.9 kg



V1619L
1600 / 1000 / 900
76.96 kg



V1819L
1800 / 1000 / 900
85.89 kg



V2019L
2000 / 1000 / 900
100.82 kg

* Dimensions exprimées en millimètre : Largeur x Profondeur x Hauteur

Éléments a multiplier les postes *



V1611L
1600 / 1000 / 1100
77.66 kg



V1811L
1800 / 1000 / 1100
86.59 kg



V2011L
2000 / 1000 / 1100
101.52 kg

Accessoires *

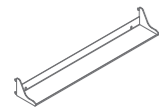

V21
700 / 120 / 85
1.8 kg

Bureaux, bureaux de direction, bureaux de direction sur meuble retour porteur, tables et tables de réunion, tables hautes

Plateau



181 Chêne naturel



191 Chêne cuivré

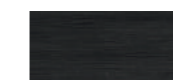

182 Chêne noir



183 Fenix - noir
mat

Pied



181 Chêne naturel



182 Chêne noir



191 Chêne cuivré



182 Chêne noir



191 Chêne cuivré



181 Chêne naturel

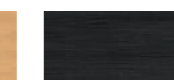

182 Chêne noir



191 Chêne cuivré



181 Chêne naturel



182 Chêne noir

Crédence de direction



181 Chêne naturel



182 Chêne noir



191 Chêne cuivré

Éléments complémentaires

Top access M10



183 Fenix - noir
mat

Mediabox



M115 Noir semi-
mat RAL9005

Le mélange des teintes chêne n'est pas possible sur une même référence.

Bureaux de direction sur meuble retour porteur

Panneau du haut et arrière



181 Chêne naturel 182 Chêne noir 191 Chêne cuivré 183 Fenix - noir mat

Corps intérieur, façade



181 Chêne naturel 182 Chêne noir 191 Chêne cuivré

Côtés du meuble



183 Fenix - noir mat

Éléments supplémentaires

Bloc tiroirs suspendu, voile de fond



181 Chêne naturel 182 Chêne noir 191 Chêne cuivré

Top access M10



183 Fenix - noir mat

Mediabox



M115 Noir semi-mat RAL9005

Armoires et rangements

Plateau, côtés du meuble



183 Fenix - noir mat

Corps extérieur, corps intérieur, façade



181 Chêne naturel 182 Chêne noir 191 Chêne cuivré

Le mélange des teintes chêne n'est pas possible sur une même référence.

Caissons

Plateau



181 Chêne naturel 182 Chêne noir 191 Chêne cuivré 183 Fenix - noir mat

Corps extérieur



183 Fenix - noir mat

Façade, corps intérieur



181 Chêne naturel 182 Chêne noir 191 Chêne cuivré

Crédence de direction

Top, base



181 Chêne naturel 182 Chêne noir 191 Chêne cuivré 183 Fenix - noir mat

Côtés du meuble



183 Fenix - noir mat

Corps intérieur, façade



181 Chêne naturel 182 Chêne noir 191 Chêne cuivré

Le mélange des teintes chêne n'est pas possible sur une même référence.

epOXIA

6 avenue Charles de Gaulle
78150 Le Chesnay
+33 1 39 66 00 77
contact@epoxia.com
www.epoxia.com



Rejoignez-nous sur nos réseaux sociaux

