

Banque d'accueil

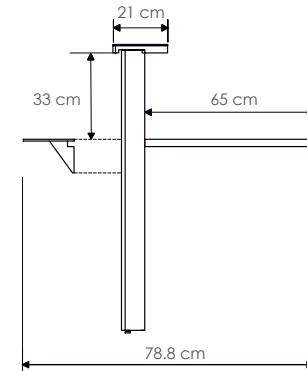

Descriptif technique / Dimensions

1

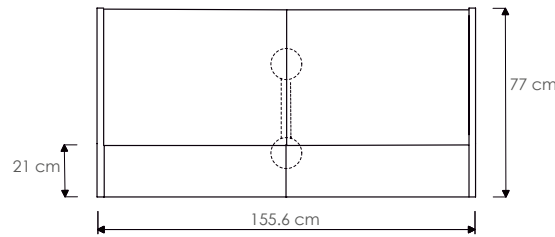
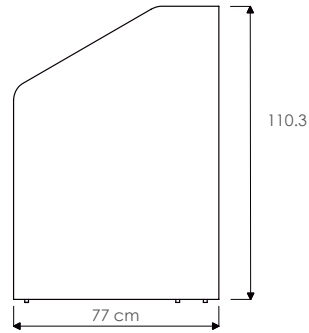
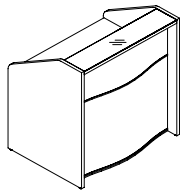

L.81/103 x P.77 cm

2

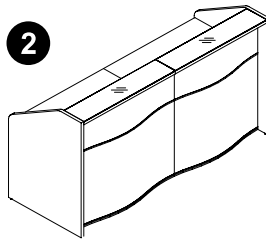

L.156/200 x P.77 cm

3

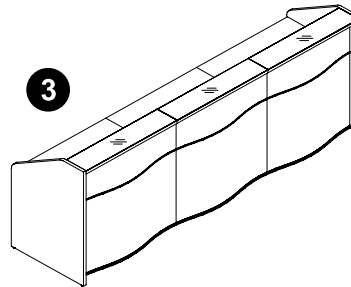

L.231/253/275/297 x P.77 cm

4

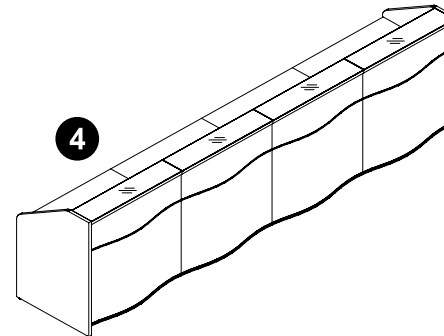

L.350/394 x P.77 cm

5

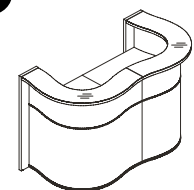

L.163 x P.85 cm

6

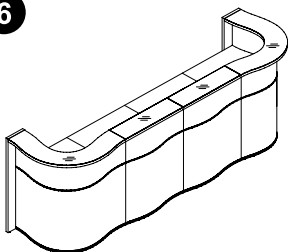

312,4 ou 356,4 X 84,1 cm

7

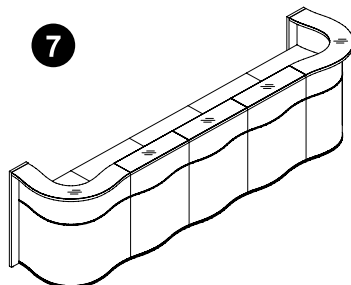

L.388/454 x P.85 cm

8

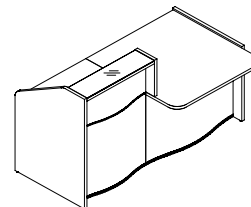

Droit ou gauche L.156/178/200 x P.102 cm

9

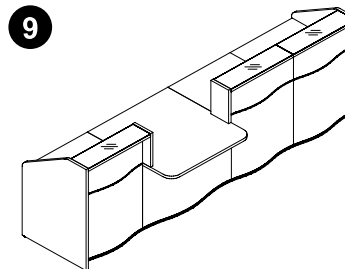

L.308/328/330/350/352/372/374/394 x P.102 cm

10

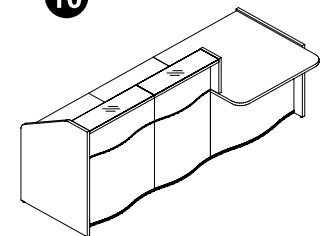

D/G L.233/253/277 x P.102 cm

La restitution des couleurs des nuanciers n'est pas contractuelle car les couleurs présentées sur un écran d'ordinateur peuvent varier selon la configuration du poste.

Banque d'accueil

11

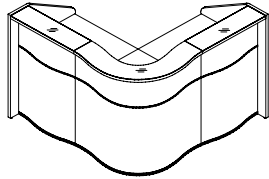

L.159 x P.159 cm ou L.181 x P.181 cm

12

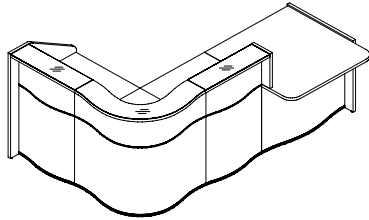

Droit ou gauche. L.236/256/258/278 x P.159/181

13

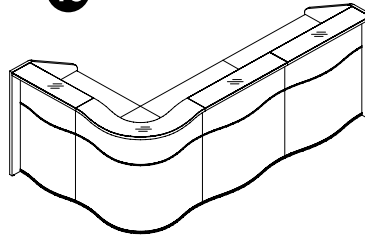

D ou G. L.235 x P.159/182 ou L.278 x P.160/181 cm

14

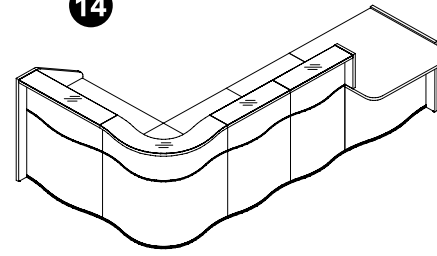

D/G L.331/355/375 x P.180 ou L.331/375 x P.181 cm

15

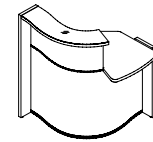

L.86 x P.93 cm

Corps Mélaminé

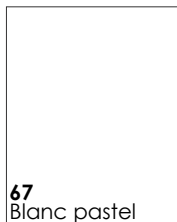
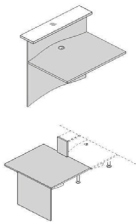

Top Verre laqué Lacobel

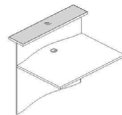

Piètement Métal

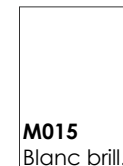

Catalogue et nuancier

Collection **WAVE**



ePOXIA
aménagement et mobilier de bureau

+33 1 39 66 00 77

Façade HPL (stratifié)

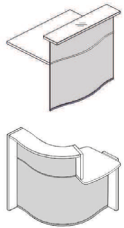

73 Blanc brillant	174 Beige mat	175 Truffe mat	176 Rouge mat	177 Gris mat RAL 7042	178 Avocat mat	179 Vert bouteille mat	180 Bleu de Prusse mat	184 Ciel mat

La restitution des couleurs des nuanciers n'est pas contractuelle car les couleurs présentées sur un écran d'ordinateur peuvent varier selon la configuration du poste.